

Door Accessories

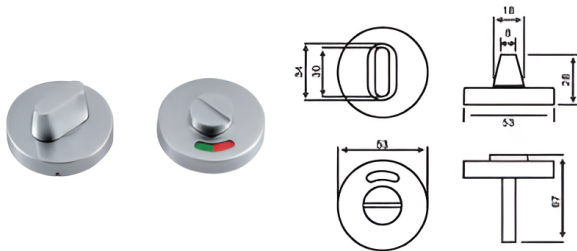

Turn and Emergency Coin Release With Indicator

EN-TE-001



EN-TE-002

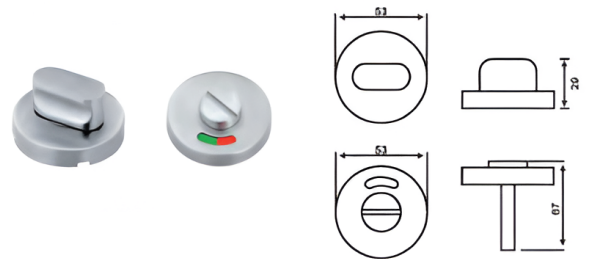

EN-TE-003

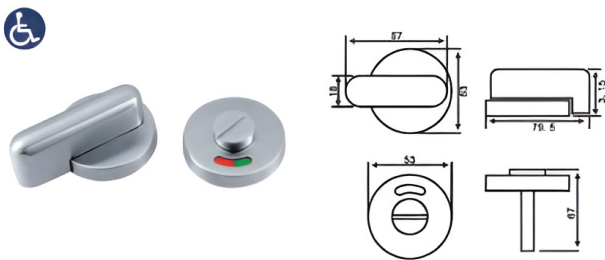

EN-TE-004

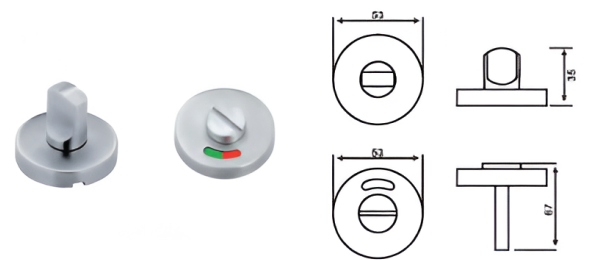

EN-TE-005

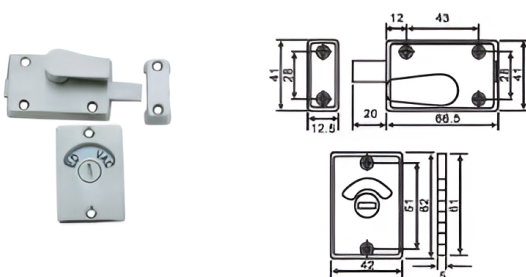

EN-TE-006

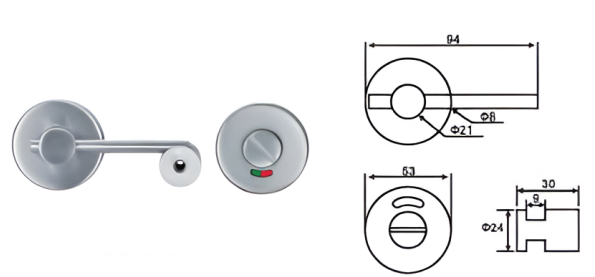

Specifications

- Material : Stainless Steel 304/ 316 grade
- Applicable : Wooden door, Metal door, Bathroom door
- Door thickness : 35mm- 55mm
- Spindle : 6 x 6, 8 x 8 mm

Turn and Emergency Coin Release With Indicator

EN-TE-007

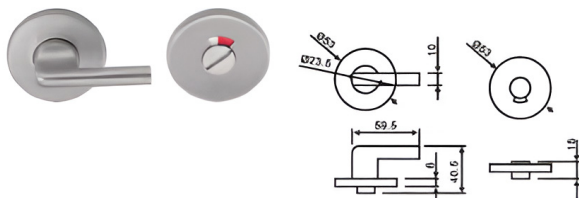

EN-TE-008

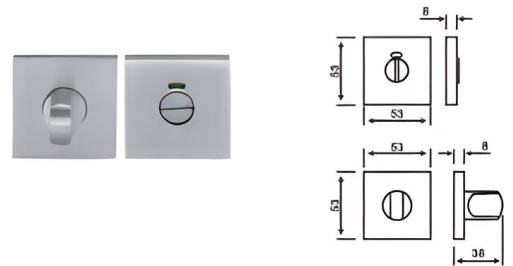

EN-TE-009

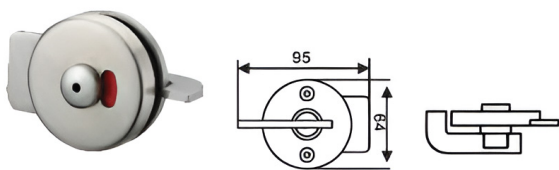

EN-TE-010

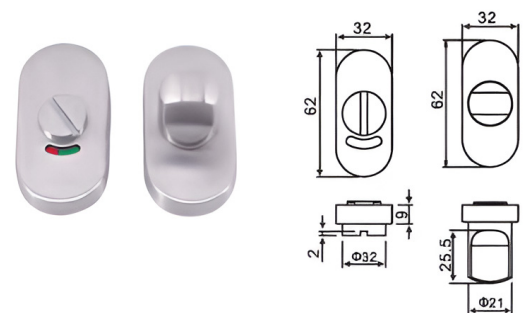

Specifications

- Material : Stainless Steel 304/ 316 grade
- Applicable : Wooden door, Metal door, Bathroom door
- Door thickness : 35mm- 55mm
- Spindle : 6 x 6, 8 x 8 mm

Door Protection Plates

Kick Plate

Armor Plate

Mop Plate

Stretcher Plate

- Dimensions: 1.5 mm Thickness
- Length : as per request
- Height : as per request
- Finish : SSS & PSS

EN-KP-200DW



Kick Plate

EN-AP-1000DW



Armor Plate

EN-MP-150DW



Mop Plate

EN-SP-300DW



Stretcher Plate

Door Push and Pull Plates

Push Plate Pull Plate Signages

- Material : Stainless Steel 304/316
- Thickness : 1.5 mm,2.0 mm,3,0 mm
- Application : Wooden Doors, Metal Doors, Aluminium Doors.

Push Plate

EN-PP-001



| Push plate (Square rype) | Item code |
|--------------------------|------------|
| A: 100 x 300 x 1.5 mm | EN-PP-001A |
| B: 100 x 300 x 2.0 mm | EN-PP-001B |
| C: 75 x 300 x 1.5 mm | EN-PP-001C |
| D: 75 x 300 x 2.0 mm | EN-PP-001D |

EN-PP-002



Push plate (Square type)

All plates are drilled and countersunk as standard with radius corners

| Engraved to order | Item code |
|-----------------------|------------|
| A: 100 x 300 x 1.5 mm | EN-PP-002A |
| B: 100 x 300 x 2.0 mm | EN-PP-002B |
| C: 75 x 300 x 1.5 mm | EN-PP-002C |
| D: 75 x 300 x 2.0 mm | EN-PP-002D |

EN-PP-003



| Push plate | Item code |
|-----------------------|------------|
| A: 100 x 400 x 1.5 mm | EN-PP-003A |
| B: 100 x 400 x 2.0 mm | EN-PP-003B |

EN-PP-004



| Push plate | Item code |
|-----------------------|------------|
| A: 100 x 400 x 1.5 mm | EN-PP-004A |
| B: 100 x 400 x 2.0 mm | EN-PP-004B |

Door Push and Pull Plates

EN-PP-005



| Blank Push | Item code |
|-----------------------|------------|
| A: 100 x 300 x 1.5 mm | EN-PP-005A |
| B: 100 x 300 x 2.0 mm | EN-PP-005B |
| C: 100 x 400 x 1.5 mm | EN-PP-005C |
| D: 100 x 400 x 2.0 mm | EN-PP-005D |

Pull Plate

EN-PP-006



| Pull handle with plate | Item code |
|------------------------|------------|
| A: 170 x 170 x 1.5 mm | EN-PP-006A |
| | EN-PP-006B |
| B: 170 x 170 x 2.0 mm | EN-PP-006C |
| C: 170 x 170 x 3.0 mm | EN-PP-006D |

Pull handle with Plate

EN-PP-007



| Pull handle with plate | Item code |
|------------------------|------------|
| A: 100 x 300 x 1.5 mm | EN-PP-007A |
| B: 100 x 300 x 2.0 mm | EN-PP-007B |
| C: 100 x 400 x 1.5 mm | EN-PP-007C |
| D: 100 x 400 x 2.0 mm | EN-PP-007D |

EN-PP-008



| Pull plate with handle | Item code |
|-----------------------------|------------|
| A: 100 x 300 x 1.5 mm | EN-PP-008A |
| B: 100 x 300 x 2.0 mm | EN-PP-008B |
| Handle : Ø22 x C to C 203mm | |

Door Push and Pull Plates

EN-PP-009

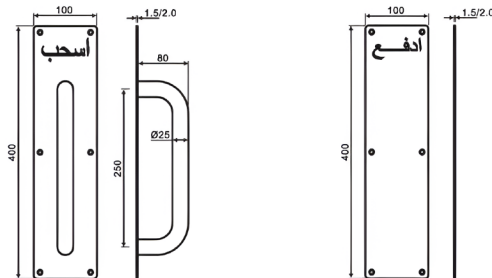

Applications : Schools, Commercial & Industrial Buildings

Multifamily & mixed-use

Government & Military Facilities

Public Buildings & Facilities

Size : A: 100 x 400 x 1.5mm EN-PP-009A

B: 100 x 400 x 2.0mm EN-PP-009B

EN-PP-010

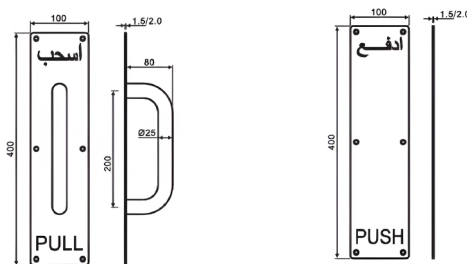

Applications : Schools, Commercial & Industrial Buildings

Multifamily & mixed-use

Government & Military Facilities

Public Buildings & Facilities

Size : A : 100 x 400 x 1.5mm EN-PP-020

B: 100 x 400 x 2.0mm EN-PP-021

Door Accessories

EN-SA-001



Male

- Washroom (Square type)
- Size : 100 x 100 x 1.5 mm

EN-SA-002



Female

- Washroom (Square type)
- Size : 100 x 100 x 1.5 mm

EN-SA-003



- Unisex Public Washroom (Square type)
- Size : 130 x 170 x 1.5 mm

EN-SA-004



Disabled

- Washroom (Square type)
- Size : 100 x 100 x 1.5 mm

EN-PP-005



- Fire Door Signature(Square type)
- Size : Ø 76 x 1.5 mm

EN-PP-006-A

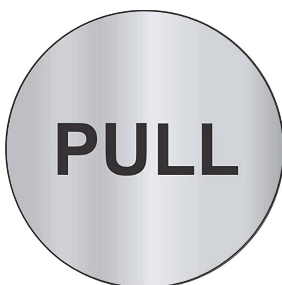

Pull plate (Round plate)

Size : Ø76 x 1.5 mm

EN-PP-006-B

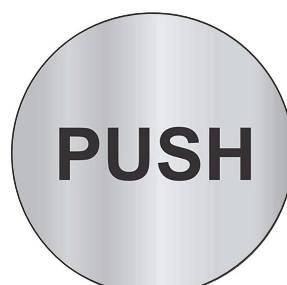

Pull plate (Round plate)

Size : Ø76 x 1.5 mm

Door Viewers

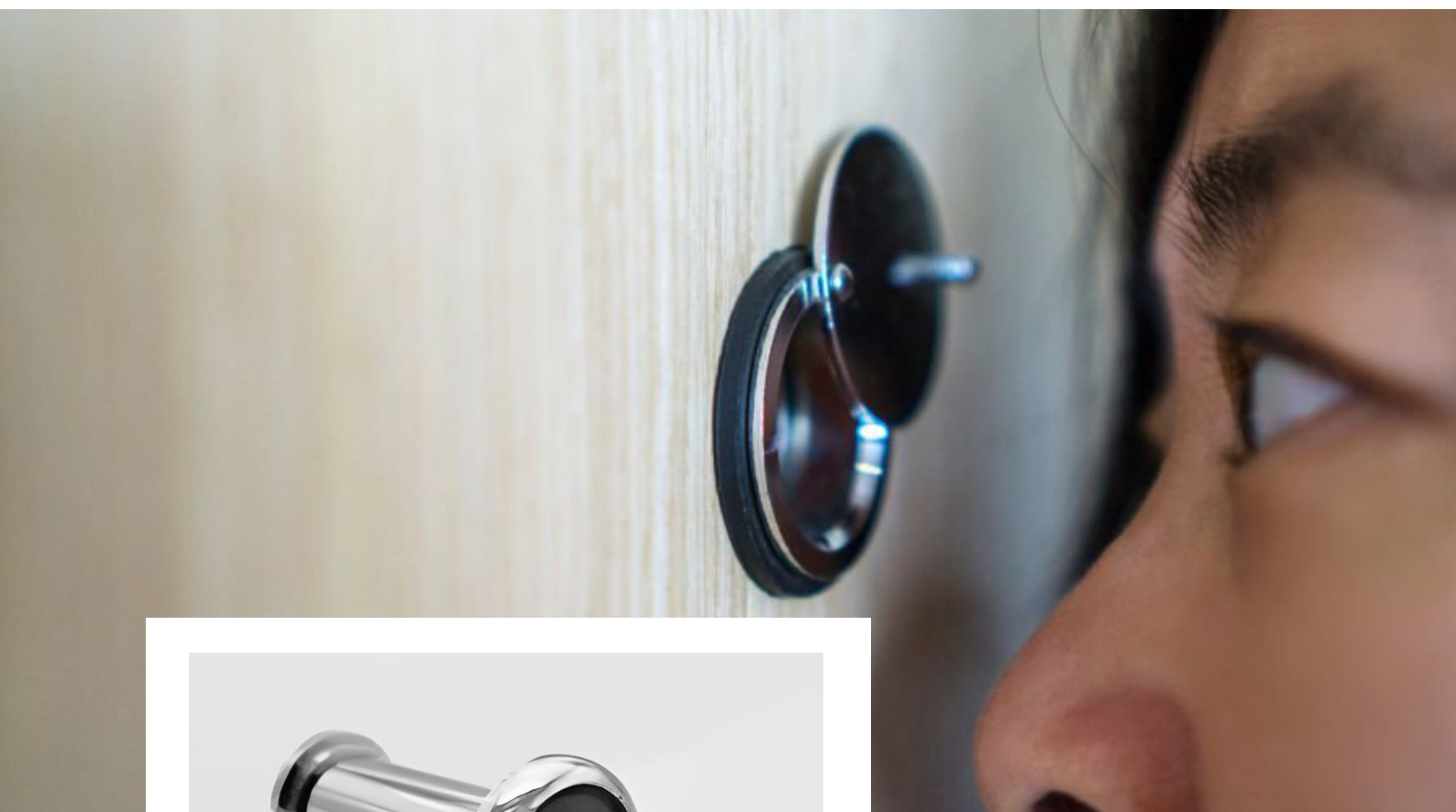

Door Viewer

EN-DV-001

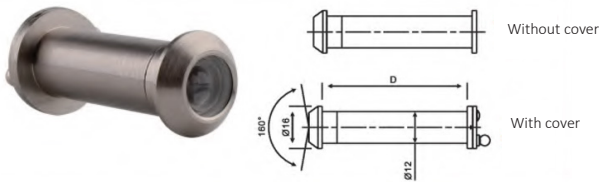

EN-DV-002

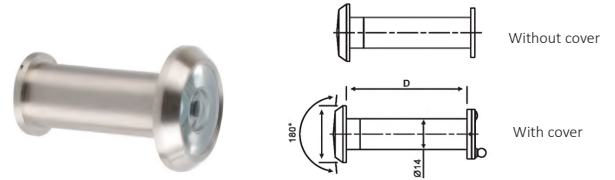

EN-DV-003

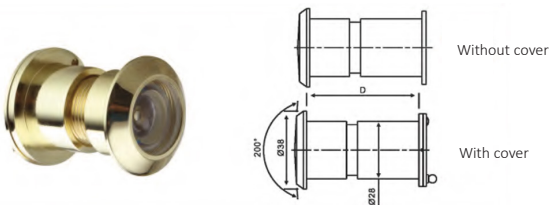

Specifications

- Material : Brass/ Zink Alloy, Glass Lens
- With cover / Without cover
- Door Thickness : 1.5 mm, 2.0 mm, 3.0 mm
- Application : Wooden Doors, Metal Doors.

Finishes



BP



GP



AB



AC



CP



SN

Fire Rated Door Viewer

EN-DV-004

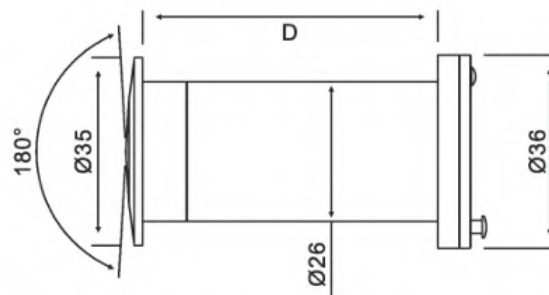

Specifications

- UL Listed peephole Fire fire rated door eye viewer for front door.
- UL Listed, UL 10C Fire Rated 1.5 hours.
- Material : Steel, glass lens

Features

- With cover/ without cover
- Application : Wooden doors, metal door
- Door thickness : D=40-65 mm

Finishes



BP



CP



SN



AB



AC



GP

Door Viewer

EN-DV-005

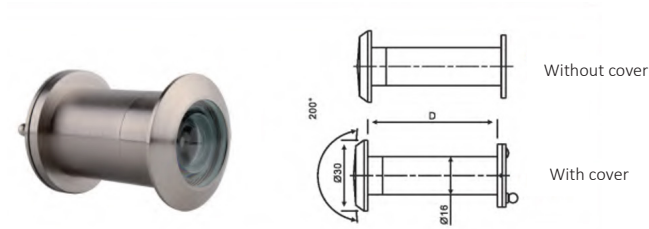

EN-DV-006

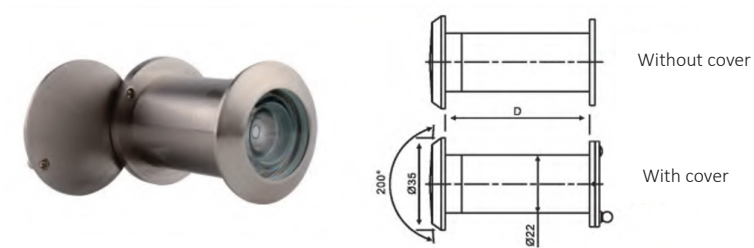

Specifications

- Material : Brass/ Zink Alloy, Glass Lens
- With cover / Without cover
- Door Thickness : 1.5 mm, 2.0 mm.3.0 mm
- Application : Wooden Doors, Metal Doors.

Finishes



BP



GP



AB



AC



CP



SN

Door Viewer

EN-DV-007

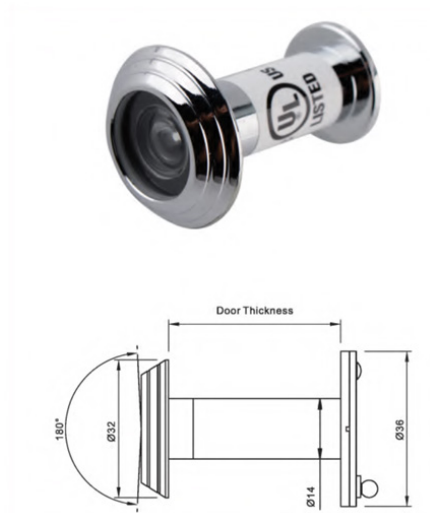

Specifications

- Material : Steel, Glass Lens
- With cover / Without cover
- Door Thickness : D = 35-60 mm
- Application : Wooden Doors, Metal Doors.

Finishes



BP



GP



AB



AC



CP



SN

Floor Mounted Door Stops

EN-DS-001

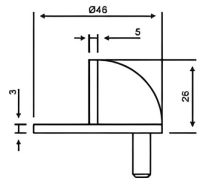

Specifications

- Stainless Steel Door Stopper
- Floor mounted type

Finishes



SSS



PSS



BP



GP



AB



AC

EN-DS-002

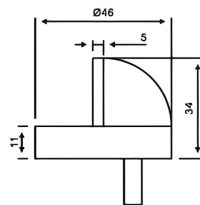

Specifications

- Stainless Steel / Zink Alloy Door Stopper
- Floor mounted type

Finishes



SSS



PSS



BP



GP



AB



AC

Floor Mounted Door Stops

EN-DS-003

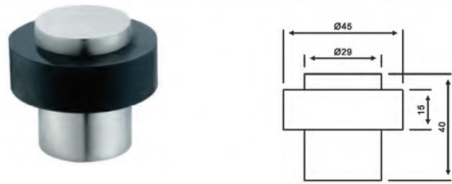

EN-DS-004

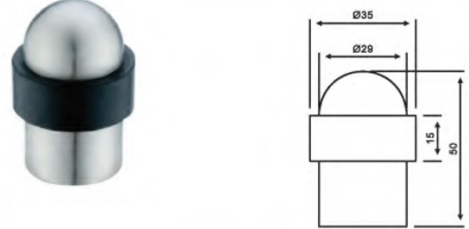

Specifications

- Stainless Steel Door Stopper
- Floor mounted type

Finishes



SSS



PSS



BP



GP



AB



AC

EN-DS-005

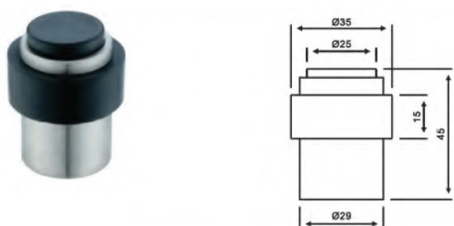

Specifications

- Stainless Steel / Zink Alloy Door Stopper
- Floor mounted type

Finishes



SSS



PSS



BP



GP



AB



AC

Floor Mounted Door Stops

EN-DS-006

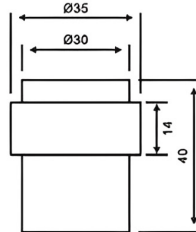

Specifications

- Stainless Steel Door Stopper
- Floor mounted type
- Screw and plug included

Finishes



SSS



PSS



BP



GP



AB



AC

EN-DS-007

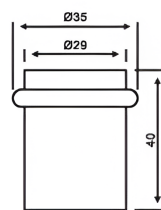

Specifications

- Stainless Steel Door Stopper
- Floor mounted type

Finishes



SSS



PSS



BP



GP



AB



AC

Floor Mounted Door Stops

EN-DS-008

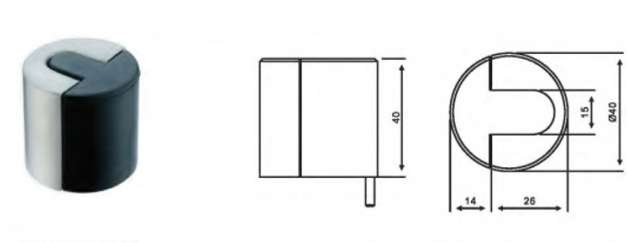

Specifications

- Stainless Steel / Zink Alloy Door Stopper
- Floor mounted type

Finishes



SSS



PSS



BP



GP



AB



AC

Wall Mounted Door Stops

EN-DS-009



Specifications

- Stainless Steel Door Stopper
- Wall mounted type
- Screw included

Finishes



SSS



PSS



BP



GP



AB



AC

Wall Mounted Door Stops

EN-DS-010

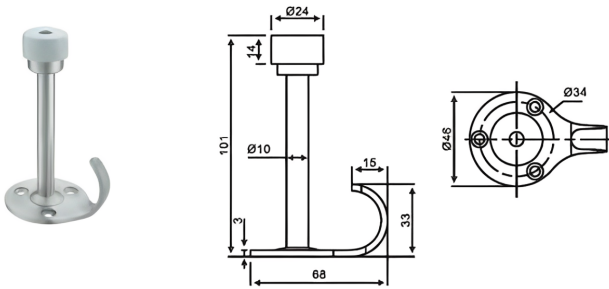

Specifications

- Stainless Steel Door Stopper
- Wall mounted type

Finishes



SSS



PSS



BP



GP



AB



AC

EN-DS-011



Specifications

- Zinc Alloy Door Holder
- Wall mounted type

Finishes



SSS



PSS



BP



GP



AB



AC



SN

Wall Mounted Door Stops

EN-DS-012

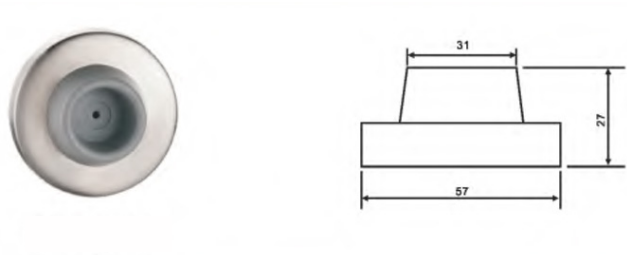

Specifications

- Stainless Steel Concave Stopper
- Wall mounted type

Finishes



SSS



PSS



BP



GP



AB



AC



SN

EN-DS-013

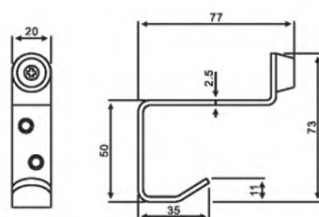

EN-DS-014

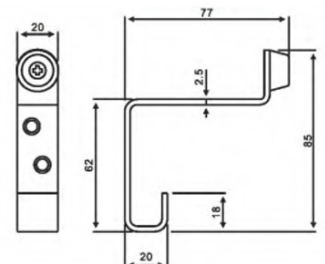

Specifications

- Stainless Steel Door Stopper
- Wall mounted type, also can be used as coat hook.
- Screws included

Magnetic Door Stops

EN-DS-015

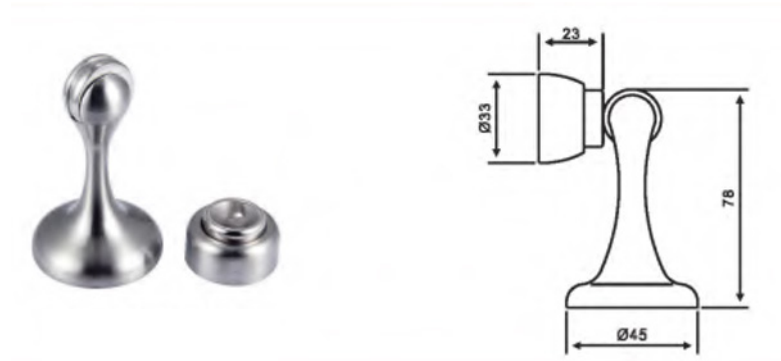

EN-DS-016

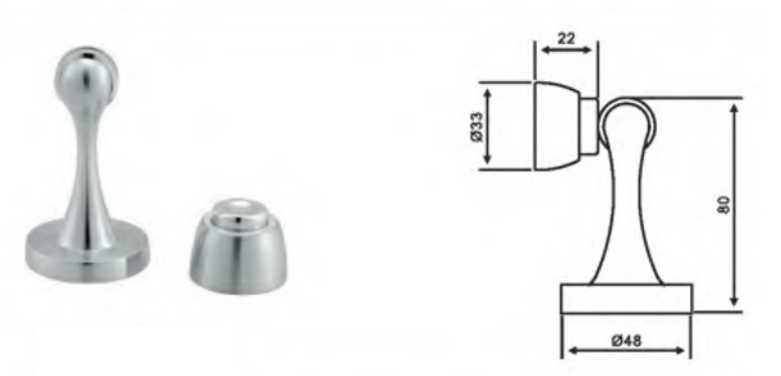

Specifications

- Stainless Steel / Zink Alloy Door Stopper, Magnetic

Finishes



SSS



PSS



AC



GP



AB



CP



NP

Magnetic Door Stops

EN-DS-017



Specifications

- Stainless Steel / Zink Alloy Door Stopper
- Floor mounted type

Finishes



SSS



PSS



BP



GP



AB



AC

EN-DS-018

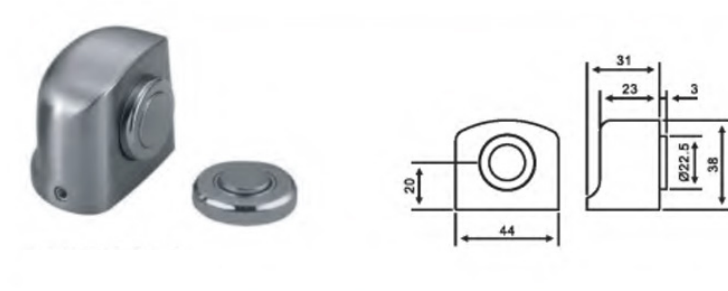

Specifications

- Zink Alloy Door Stopper, Magnetic
- Floor mounted type

Finishes



BP



GP



AB



AC



CP



SN

Wall Mounted Door Stops

EN-DS-019

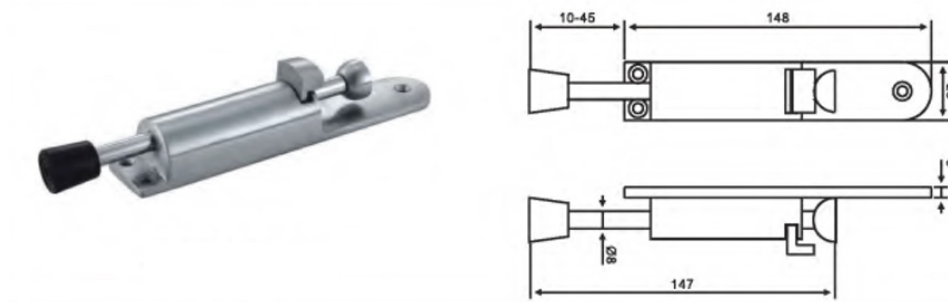

EN-DS-020

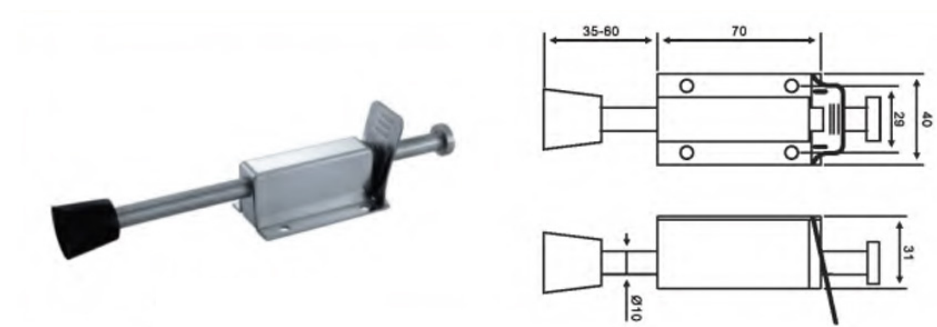

Specifications

- Foot Operated Door Holder Door Mounted Type
- Material : Stainless Steel/ Zink Alloy

Finishes



SSS



PSS



SNP



SCP



AB



AC

Floor Mounted Door Stops

EN-DS-021

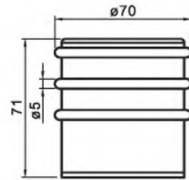

Specifications

- Stainless Steel Door Stopper
- Floor mounted type

Finishes



SSS



PSS



BP



GP



AB



AC

EN-DS-022

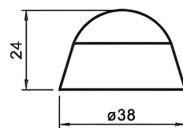

Specifications

- Stainless Steel Door Stopper
- Floor mounted type

Finishes



SSS



PSS



BP



GP



AB



AC

Floor Mounted Door Stops

EN-DS-023

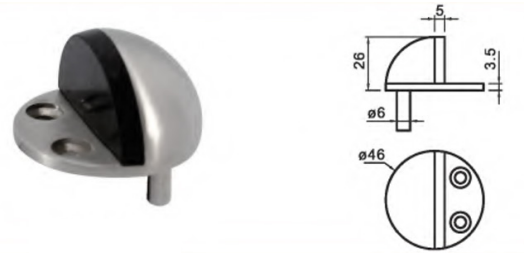

Specifications

- Stainless Steel Door Stopper
- Floor mounted type

Finishes



SSS



PSS



BP



GP



AB



AC

Wall Mounted Door Stops

EN-DS-024

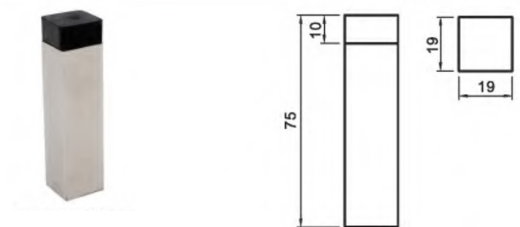

Specifications

- Stainless Steel Door Stopper
- Wall mounted type

Finishes



SSS



PSS



BP



GP



AB



AC

Floor Mounted Door Stops

EN-DS-025

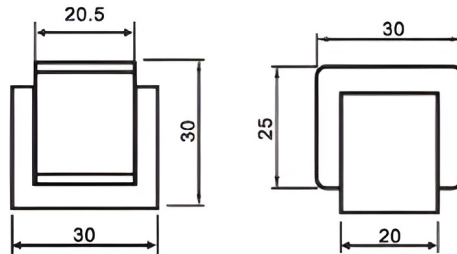

Specifications

- Stainless Steel Door Stopper
- Floor mounted type

Finishes



SSS



PSS



BP



GP



AB



AC

Wall Mounted Door Stops

EN-DS-026



Specifications

- Stainless Steel Door Stopper
- Wall mounted type

Finishes



SSS



PSS



BP



GP



AB



AC

Magnetic Door Stops

EN-DS-027

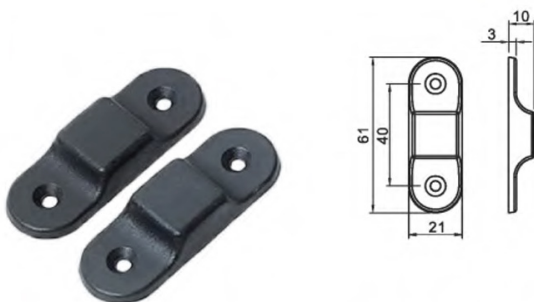

Specifications

- Rubber Magnetic Door Stopper Catch Kit For Bifold Door
- Used on bifold Doors
- Material : Rubber

Door Stops

EN-DS-028

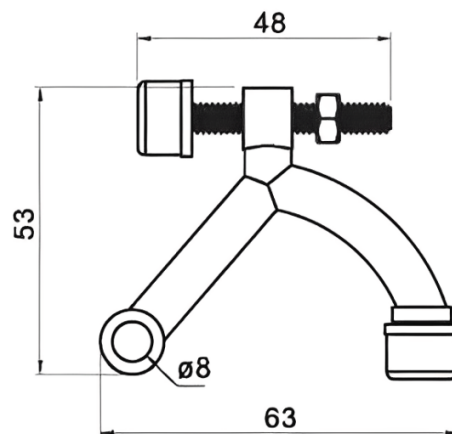

Specifications

- Hinge pin Door Stopper
- Stainless Steel
- No fasteners necessary
- Fits most standard residential door hinges
- Self-adjusting pad protects your door
- Decorative finish to match any home decoration

Finishes



SSS



PSS



BP



GP



AB



AC

Door Holder and Stoper

EN-DS-029

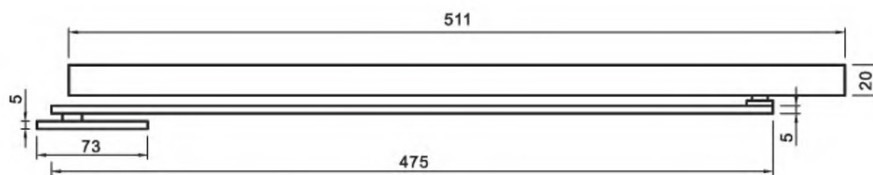
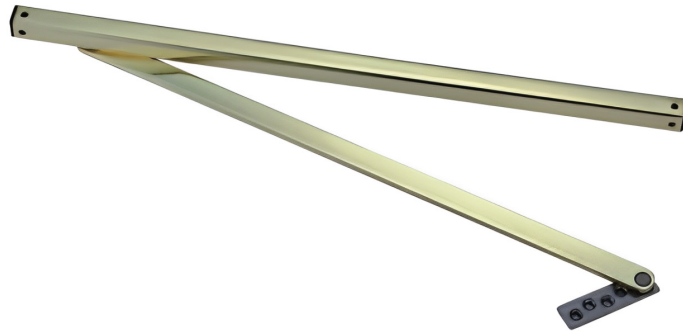

Specifications

- Overhead Door Holder & Stopper
- Stainless Steel
- Non- Handed
- Single-Acting Doors
- Interior/Exterior Applications
- Durable
- Easy to Intall
- Improved Corrosion Resistance

Floor Mounted Door Stops

EN-DS-030

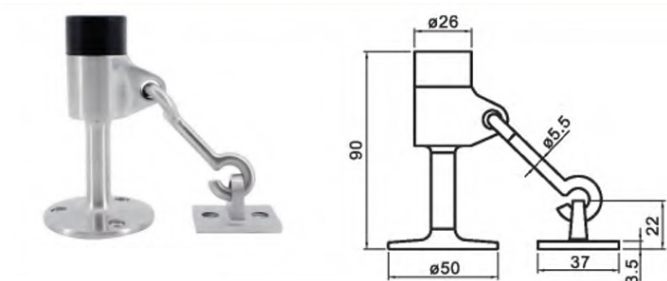

EN-DS-031

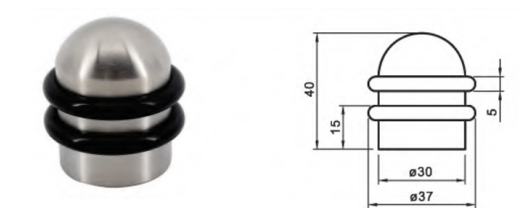

EN-DS-032

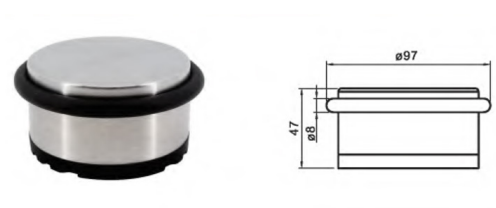

Specifications

- Stainless Steel Door Stopper
- Floor mounted type

Finishes



SSS



PSS



BP



GP



AB



AC

Wall Mounted Door Stops

EN-DS-033



Specifications

- Stainless Steel Door Stopper
- Wall mounted type

Finishes



SSS



PSS



BP



GP



AB



AC

Roller Catch

EN-RL-001

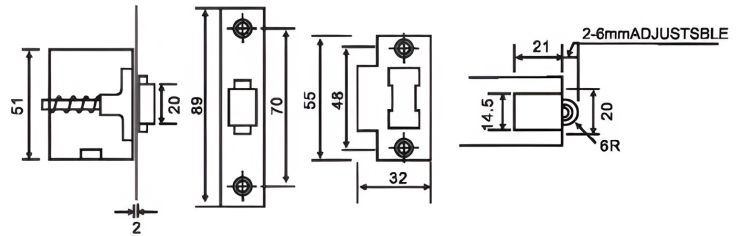

Specifications

- Stainless Steel Roller Catch

EN-RL-002

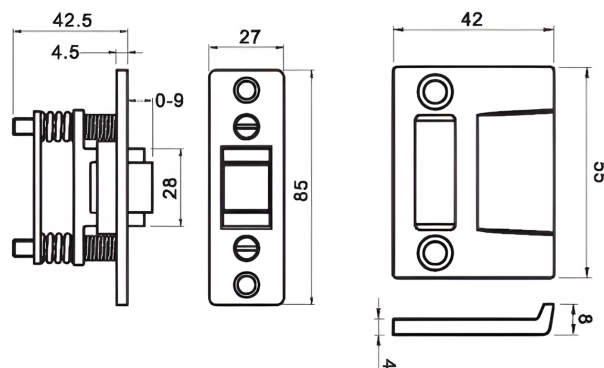

Specifications

- Heavy Duty Roller Catch
- Stainless Steel 304 grade / Brass
- Easy installation
- Adjustable roller

Finishes



SSS



PSS



CP



GP



AB



AC



SN

Flush Bolt

EN-FBW-08

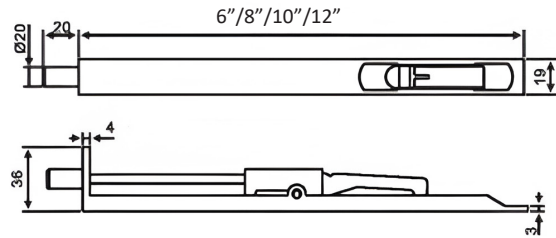
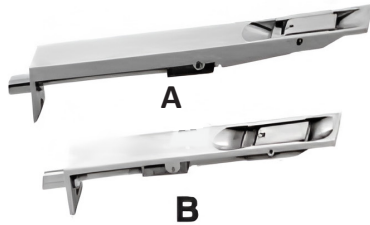

Specifications

- Stainless Steel Flush Door Bolt for Wooden door
- Size : 8", 10", 12", 18", 24"

EN-FBM-08

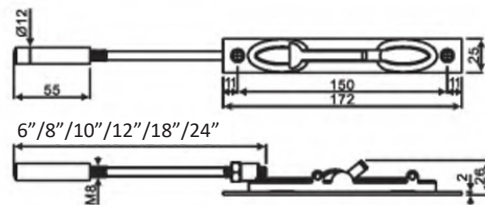

Specifications

- Stainless Steel Flush Door Bolt for Metal door
- Size : 6", 8", 10", 12", 18", 24"

NOTE: Last two digit suffixes in the itemcode varies as per rod length as indicated above

Finishes



SSS



PSS



BP



GP



AB



AC

Flush Bolt

EN-AFBM-12

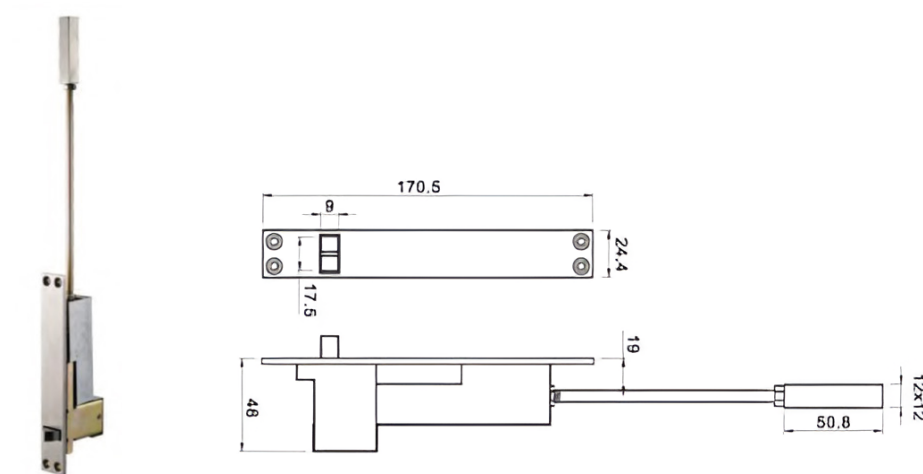

Specifications

- Automatic Bolt for Metal door
- Fully Automatic-inactive door is latched when active door closes, bolts retract when active door is opened
- Non handed
- Bolts have 3/4" throw with a T/8 vertical adjustment
- Standard Rod Length is 12", which is measured from the center of the flush bolt body to the bolt tip
- Optional rod lengths available for top bolt for 18", 24", 36" and 48"

NOTE: Last two digit suffixes in the itemcode varies as per rod length as indicated above

Finishes



SSS



PSS



BP



GP



AB



AC

Flush Bolt

EN-AFBW

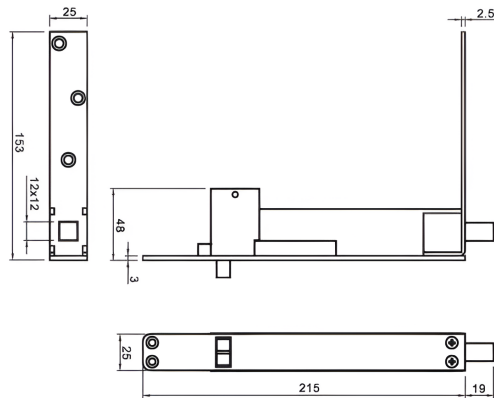

Specifications

- Fully Automatic-inactive door is latched when active door closes, bolts retract when active door is opened
- Non handed
- Stainless steel
- Size : 215 x 25mm

NOTE: Last two digit suffixes in the itemcode varies as per rod length as indicated above

Finishes



SSS



PSS



BP



AC



AB

Security Door Guard

EN-DG-001

Security Door Guard

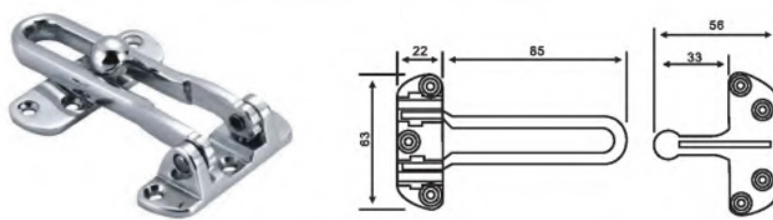

EN-DG-002

Concealed Security Door chain

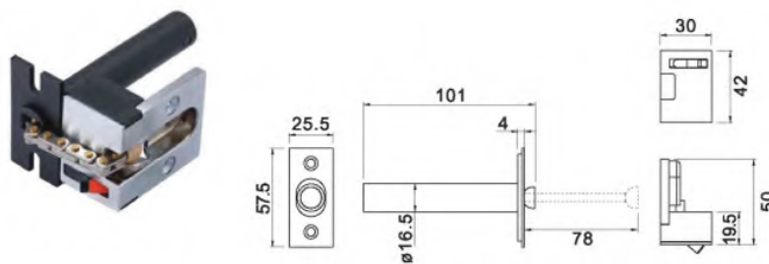

EN-DG-003

Security Door chain



Specifications

- Material : Stainless Steel / Zink alloy

Finishes



SSS



PSS



SNP



SCP



AB



AC

Dust Proof Socket

EN-DP-001

Dust Proof Socket / Strike

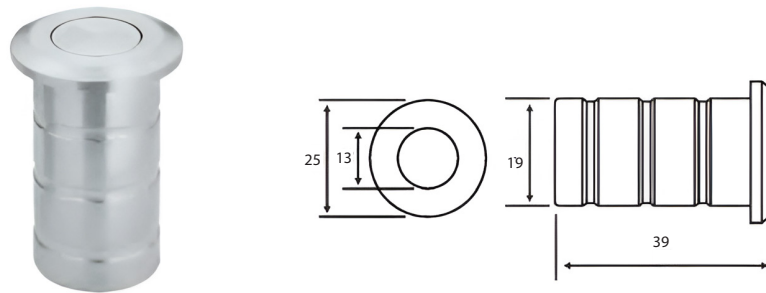

Finishes



SSS



PSS



PVD



AB



AC

EN-DP-002

Dust Proof Strike with Plate

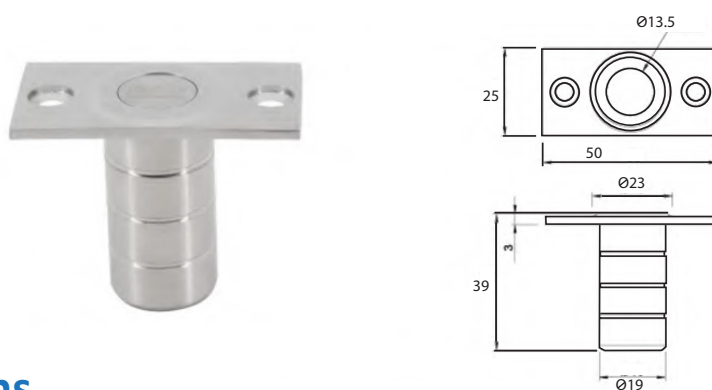

Specifications

- Material : Stainless Steel

Finishes



SSS



PSS



PVD



AB



AC

Dust Proof Socket

EN-DP-003

Dust Proof Strike with Plate

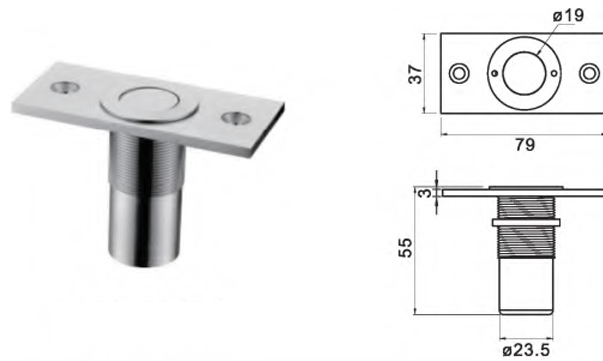

Specifications

- Material : Brass

Finishes



P&L



S&L



SCP



AB



AC



SNP

EN-DP-004

Dust Proof Strike

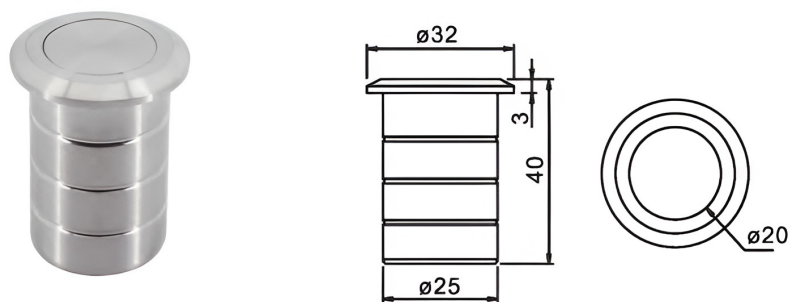

Specifications

- Material : Stainless Steel

Finishes



SSS



PSS



PVD



AB



AC

Flush Pull Handle

EN-FP-001

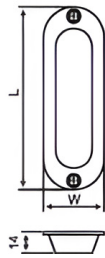

EN-FP-002

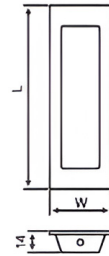

EN-FP-003

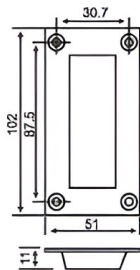

EN-FP-004

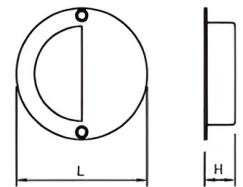

EN-FP-005

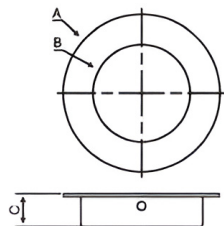

EN-CP-001

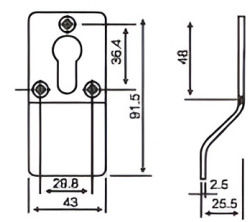

Specifications

- Material : Stainless Steel 304 / 316 grade

Finishes



SSS



PSS



MB



AB



AC

Flush Pull Handle

EN-CH-001

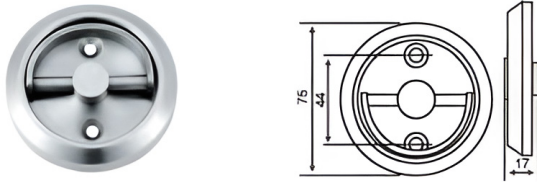

EN-CH-002

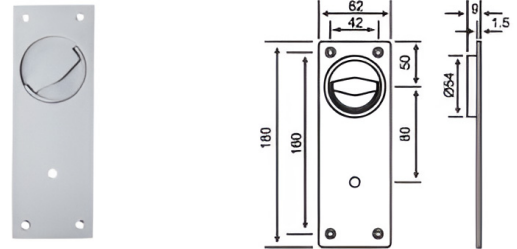

EN-CH-003

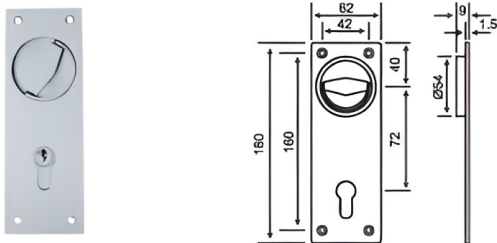

EN-CH-004

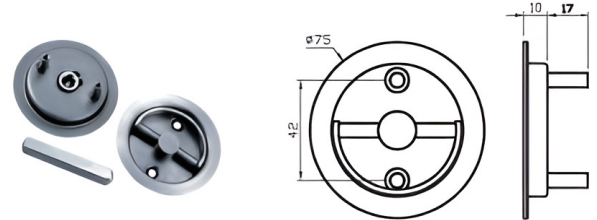

EN-FP-006

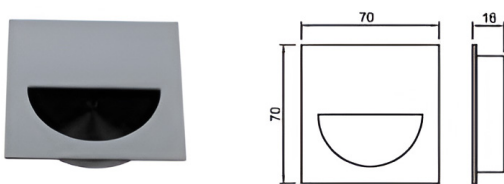

EN-FP-007

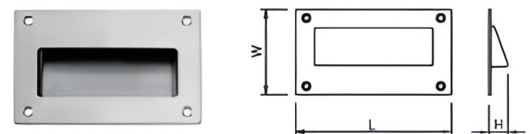

Specifications

- Material : Stainless Steel 304 / 316 grade

Finishes



SSS



PSS



MB



AB



AC

Flush Pull Handle

EN-FP-008

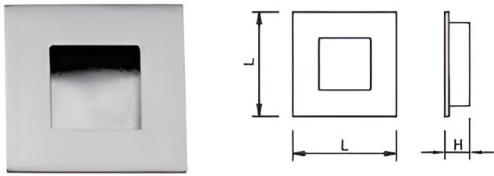

EN-FP-009



EN-FP-010

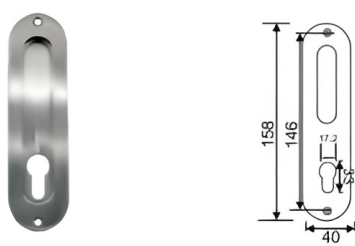

EN-FP-011

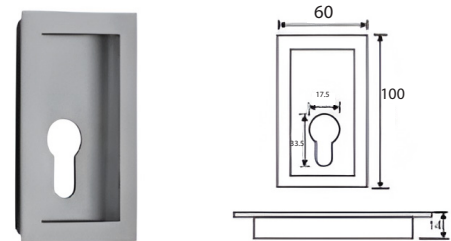

Specifications

- Material : Stainless Steel 304 / 316 grade

Finishes



SSS



PSS



MB



AB



AC

Europrofile Round Escutcheon

EN-ES-001

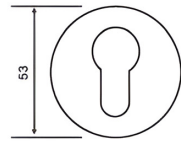

EN-ES-002

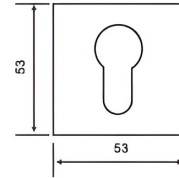

EEN-ES-003

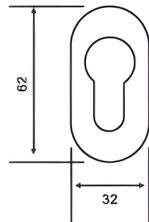

EN-ES-S004

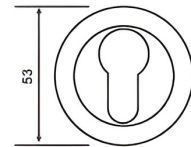

EN-ES-005

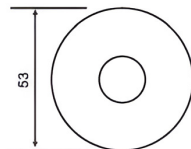

EN-ES-006

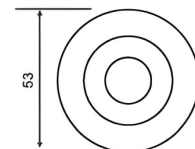

EN-ES-007

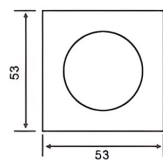

EN-ES-008

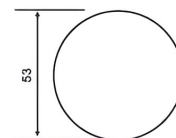

Finishes



SSS



PSS



PVD

















AB



MB

Finishes

| | | |
|-----|---------------------------|---|
| SSS | Satin Stainless Steel |  |
| PSS | Polished Stainless Steel |  |
| PVD | Physical Vapor Deposition |  |
| BP | Polished Brass |  |
| GP | Gold Plated |  |
| AB | Antique Brass |  |
| AC | Antique Copper |  |
| CP | Polished Chrome |  |
| SN | Satin Nickel |  |
| SCP | Satin Chrome Plate |  |
| SNP | Satin Nickel Plate |  |
| P&L | Polish + Clear coating |  |
| S&L | Satin + Clear coating |  |
| MB | Matte Black |  |